



Impressa E Series

Fully Automatic
Coffee & Espresso Center
with Clearyl Water Care System

Operating Instructions
and Warranty

Customer Service 1-800-220-5701

IMPORTANT SAFEGUARDS

When using electrical appliances, basic safety precautions should always be followed, including the following:

1. Read all instructions.
2. Do not touch hot surfaces. Use handles or knobs.
3. To protect against fire, electric shock and personal injury, do not immerse cord, plugs or appliance in water or other liquids.
4. Close supervision is necessary when any appliance is used by or near children.
5. Unplug from outlet when not in use and before cleaning. Allow it to cool before putting on or taking off parts, and before cleaning the appliance.
6. Do not operate any appliance with a damaged cord or plug or after the appliance malfunctions, or has been damaged in any manner. Return appliance to the nearest authorized service facility for examination, repair or adjustment.
7. The use of accessory attachments not recommended by the appliance manufacturer may result in fire, electric shock, or personal injury.
8. Do not use outdoors.
9. Do not let the cord hang over the edge of a table or counter, or touch hot surfaces.
10. Do not place on or near a hot gas or electric burner, or in a heated oven.
11. Always attach plug to appliance first, then plug cord into

wall outlet. To disconnect, turn any control to “off” then remove plug from wall outlet.

12. Do not use appliance for other than intended use.
13. Use extreme caution when disposing hot steam.
14. For household use only.

SAVE THESE INSTRUCTIONS SPECIAL CORD SET INSTRUCTIONS

Regarding your cord set:

- A. A short power-supply cord (or detachable power-supply cord) is to be provided to reduce risks resulting from becoming entangled in or tripping over a longer cord.
- B. Longer detachable power-supply or extension cords are available and may be used if care is exercised in their use.
- C. If a long detachable power-supply cord or extension cord is used,
 - 1) The marked electrical rating of the detachable power-supply cord or extension cord should be at least as great as the electrical rating of the appliance,
 - 2) If the appliance is of the grounded type, the extension cord should be a rounding type 3-wire cord, and
 - 3) The longer cord should be arranged so that it will not drape over the counter-top or table-top where it can be pulled on by children or tripped over.

D. This appliance has a polarized plug (one blade is wider than the other). As a safety feature, this plug will fit in a polarized outlet only one way. If the plug does not fit fully in the outlet, reverse the plug. If it still does not fit, contact a qualified electrician. Do not attempt to defeat this safety feature.

CAUTION

This appliance is for household use. Any servicing other than cleaning and user maintenance should be performed by an authorized service representative.

- Do not immerse base in water or try to disassemble.
- To reduce the risk of fire or electric shock, do not remove the base. No user serviceable parts inside. Repair should be done by authorized service personnel only.
- Check voltage to be sure that the voltage indicated on the name plate agrees with your voltage.
- Never use warm or hot water to fill the water container! Use cold water only!
- Keep your hands and the cord away from hot parts of the appliance during operation.
- Never clean with scouring powders or hard implements.

JURA-CAPRESSO

Jura was founded in 1931 in Switzerland. Capresso was founded in 1994 in the USA. Both companies have joined forces in the US to bring you the finest Fully Automatic Coffee Centers available anywhere. With innovative and user-friendly features, high quality materials, clear instructions and superb customer service, we are sure you will experience the best coffee, espresso, cappuccino or latte you have ever had. We hope you will enjoy your new Fully Automatic Coffee Center and will recommend it to your friends. For more information about our products visit our website www.capresso.com.

Michael Kramm, President

Fig. 1

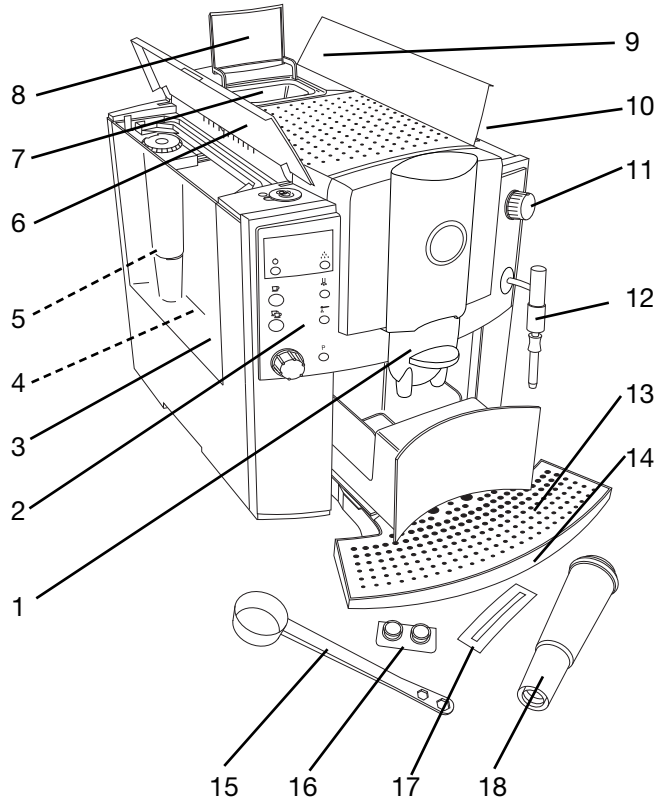

1. Height-Adjustable Coffee Spout
2. Operating Buttons (See Fig. 3)
3. Removable Water Tank
4. Low Water Flotation Device (See Fig. 7.4)
5. Clearyl Water Care Cartridge (Not Installed)
6. Lid for Water Tank
7. Ground Coffee Funnel
8. Lid for Ground Coffee Funnel
9. Lid for Bean Container
10. Bean Container (See Fig. 5)
11. Steam/Water Selector (See Fig. 4)
12. Dual Frother Plus
13. Stainless Steel Removable Grid
14. Removable Drawer
15. Measuring Scoop
16. Two Cleaning Tablets (white)
17. Water Hardness Indicator Strip
18. Clearyl Water Cartridge (unpacked)

Fig. 2

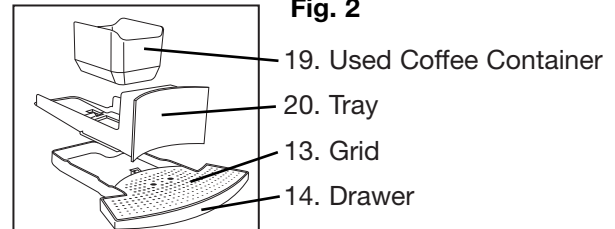

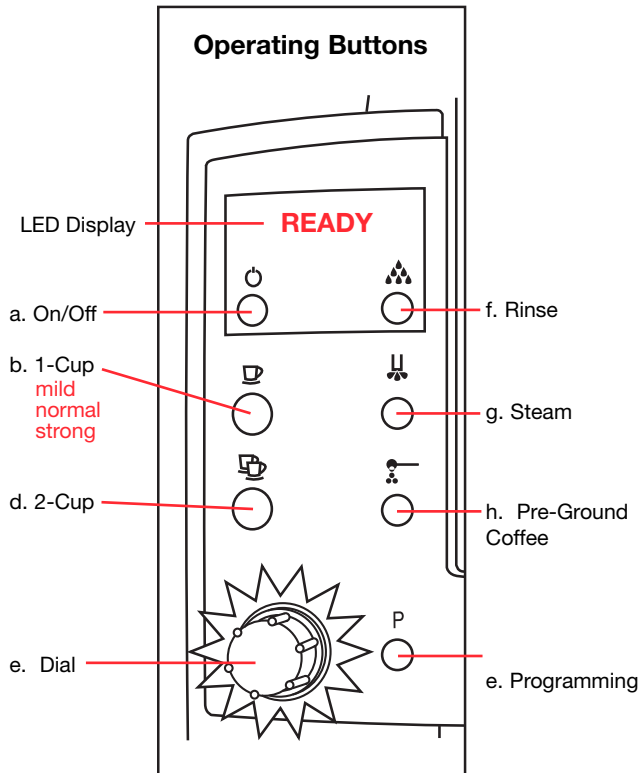

Fig. 3

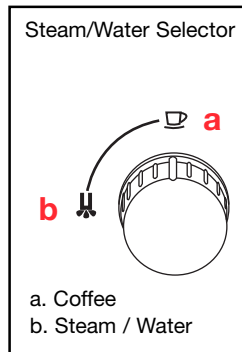

Fig. 4

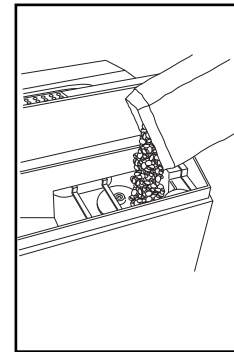

Fig. 5

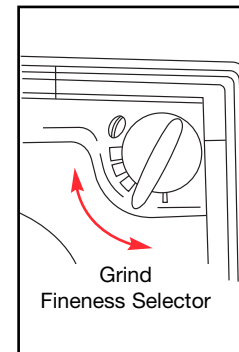

Fig. 6

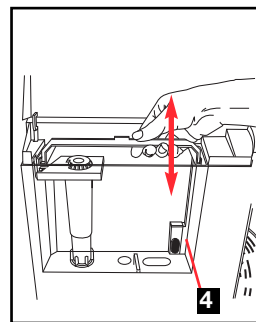

Fig. 7



Fig. 8

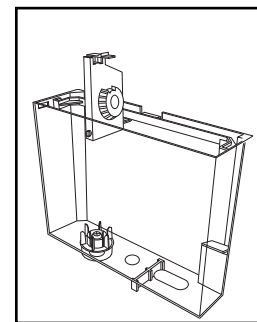

Fig. 9

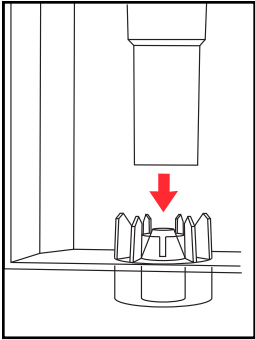

Fig. 10

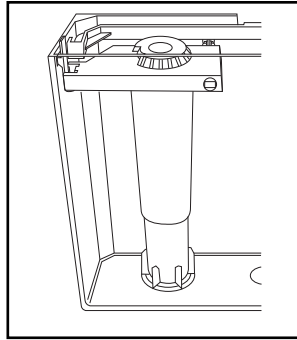

Fig. 11

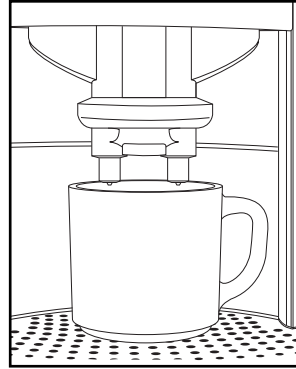

Fig. 12

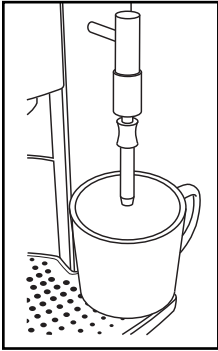
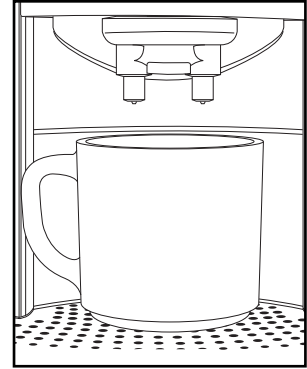

Fig. 13

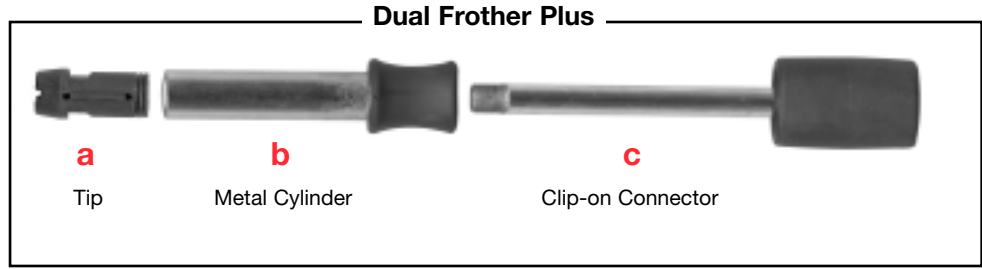

Fig. 14

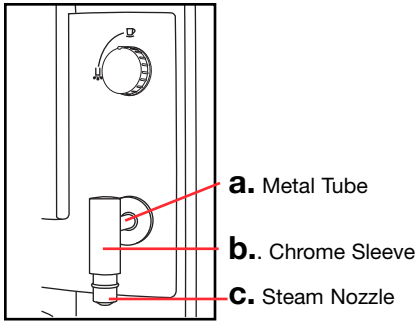

Fig. 15

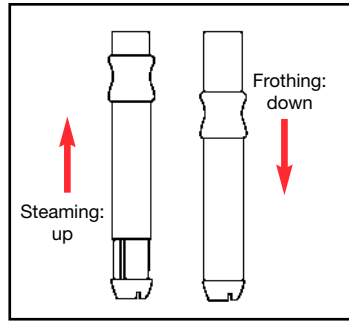

Fig. 16

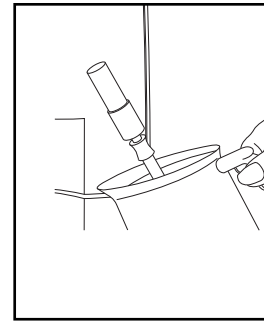

Fig. 17

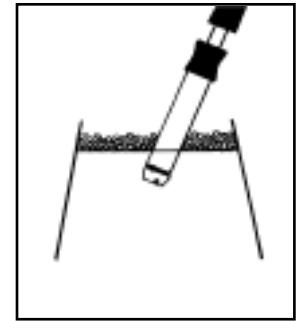

Fig. 18

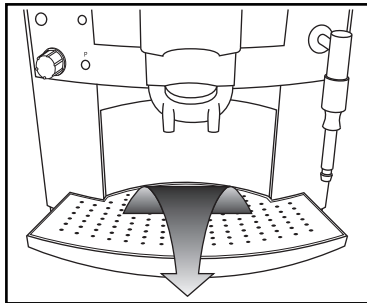

Fig. 19

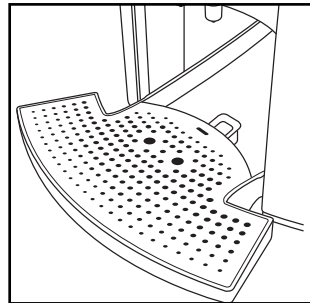

Fig. 20

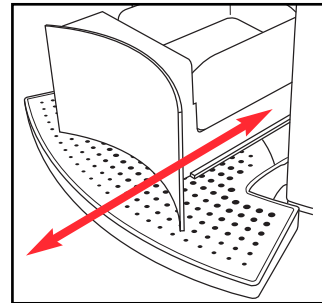

Fig. 21

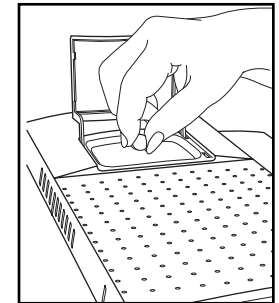

Fig. 22

Table of Contents

	Page		Page
Important Safeguards / Jura-Capresso.....	2	18. PROGRAMMING	17
Illustrations.....	4–7	a. AROMA	17
1. Product Registration.....	9	b. Auto Shut-Off	18
2. Operating Instructions / Customer Service.....	9	c. Stats (Usage).....	18
3. WELCOME TO THE IMPRESSA E SERIES	9	d. Language Selection	18
a. "Crema Coffee" and Pressure Brewing	9	e. ML / OZ.....	18
b. Different Coffee Drinks.....	10	f. Rinse	18
c. Coffee Facts.....	10	19. CARE AND MAINTENANCE	19
4. Please Don't / Please Do	10	a. Fill Water	19
5. Factory Settings	11	b. Empty Tray / Empty Grounds.....	19
6. PREPARING MACHINE FOR THE FIRST TIME	11	c. Fill Beans.....	19
7. Adding Coffee Beans	11	d. Stones and Beans.....	19
8. Adjusting the Grinder	12	e. General Cleaning Instructions.....	19
9. DAILY PREPARATION	12	f. Emptying System Before Transport	19
10. Grinding and Brewing.....	12	20. AUTOMATIC CLEANING CYCLES	20
a. Selecting Cup Size and Strength.....	12	a. Rinsing	20
11. Using Pre-Ground Coffee.....	13	b. Cleaning with Special Tablet.....	20
12. Using Hot Water.....	13	c. Decalcifying Procedure	21
13. FROTHING AND STEAMING	14	21. Tips for Better Coffee.....	22
14. Heating and Frothing Milk	14	22. SUPPLIES	22
15. Cleaning the Dual Frother Plus	15	23. frothXpress Plus System (sold separately).....	22
16. CLEARYL WATER CARTRIDGE	15	24. Troubleshooting	22
a. Installing and Activating the Clearyl Cartridge	15	25. WARRANTY	23
b. Replacing the Clearyl Cartridge.....	16	Address Information / Customer Service.....	Back Cover
17. Adjusting the Water Hardness.....	16		

1. PRODUCT REGISTRATION

Please read the enclosed product registration form now. Fill it out and mail or fax it to us within two weeks after purchasing your machine or register online through our website: www.cappresso.com. **Important:** This registration is part of your warranty (chapter 24).

2. OPERATING INSTRUCTIONS / CUSTOMER SERVICE

Thank you for choosing this Jura-Cappresso product.

- Please study these **Operating Instructions** carefully before using your new machine. We highly recommend viewing the enclosed **video**.
- Also included is a **Quick Reference Guide**, keep it next to your machine.
- For further information please call our **TOLL FREE number: 1-800-220-5701, Mon-Fri 9AM – 9PM & Sat 9AM – 5PM Eastern Standard Time**. If you call at any other time please leave a message with your telephone number and when we can call you back. You can send us a **FAX at: 201-767-9684** or **EMAIL us at contact@cappresso.com**

3. WELCOME TO THE IMPRESSA E Series

This fully automatic coffee center is completely programmable and extremely user friendly. Your Impressa E can prepare one or two cups of crema coffee at a time. The two-step pressure brewing system – well known in commercial applications – was adapted and refined by Jura coffee specialists and is the trademark of each Jura-Cappresso coffee center. This Pre-Brew Aroma-System ensures optimal coffee extraction and will finish every cup with a rich layer of "crema" – proof for perfectly pres-

sure brewed coffee. Just press one of the two cup buttons and your Impressa E will grind, tamp and brew your personal cup of coffee. The integrated solid steel conical burr grinder grinds beans to the preferred fineness. A separate funnel lets you use pre-ground coffee. All coffee, water and steam functions are programmable to your own personal taste. Make any size cup of coffee between 1 and 16 oz. The Dual Frother Plus* lets you froth and steam milk for delicious cappuccinos and lattes. The frother will deliver unlimited amounts of steam. The stainless steel lined ThermoBlock prevents water from coming in contact with aluminum and allows you to brew coffee immediately after frothing (no purging). The hot water function lets you prepare tea and other beverages in seconds. All important functions such as water level, bean container, used coffee container and water filter are monitored automatically. You can change the language and can check how many cups of coffee you made.

Enjoy your Impressa E!

* The frothXpress Plus, an automatic frothing device, is separately available (chapter 23). For details for the frothXpress Plus accessory see video

3a. "CREMA COFFEE" AND PRESSURE BREWING

According to the majority of coffee experts, grinding, tamping and brewing under high pressure is the ideal extracting process for maximum flavor and aroma. Your Jura-Cappresso automatic coffee center will always produce espresso and coffee with a thick, foamy layer called "crema." The crema traps the fine aromatics and the light gaseous flavors that register on the palate. The high pressure and the short brewing time prevent the

extraction of bitter oils and release less caffeine than any other brewing method. You will always make the absolute freshest and most aromatic cup of coffee. This is the reason why many European restaurants and hotels serve fresh pressured brewed coffee only. Experiment with your new machine and prepare yourself the best and most enjoyable cup of coffee!

3b. DIFFERENT COFFEE DRINKS

Here are some guidelines for the most popular coffee drinks:

- Ristretto: 1/2 to 1 oz. of coffee. Sweeten to taste
- Espresso: 1 to 2 oz. coffee. Sweeten to taste
- Double Shot: 3 to 4 oz. of coffee. Sweeten to taste
- Crema Coffee: 5 to 8 oz. of coffee
- Cappuccino: Espresso plus 3 to 4 oz. of hot frothed milk.
- Latte: Espresso plus 3-5 oz. steamed milk with little or no froth.
- Café Mocha: Make Espresso then add chocolate syrup to the milk before frothing/steaming.

Experiment with the size of your milk based drinks. For stronger coffee taste add more coffee, for more milk taste use more frothed milk.

3c. COFFEE FACTS

- **Caffeine** is tasteless. A "strong" coffee or espresso is mostly the result of the amount of coffee in relation to the amount of water. The longer a bean is roasted, the less caffeine it has.
- **Arabica and Robusta** are two genetically different kinds of beans. "Arabica" beans have more flavor and a little less caffeine than "Robusta" beans which are mostly used in lower priced coffees and instant coffees.
- **Espresso** is not a bean, it's the way the coffee is roasted and

prepared. Typical US espresso roasts result in darker beans with an oily outside. European espresso roasts are medium brown with no or very little oils showing on the outside.

Please note: Dark, oily beans: see chapter 7.

4. PLEASE, DON'T... (or you void your warranty protection):

- Never pull out the drawer during the brewing process.
- Never fill instant coffee into the bean container or ground coffee funnel; it can damage the brewing chamber.
- Never fill sugar coated coffee beans into the bean container.
- Never fill frozen beans into the bean container. If you store beans in the freezer, let them thaw for 3 to 4 hours before filling them into the bean container.
- Never fill anything other than coffee beans into the bean container (no chocolate, rice, nuts, spices, etc.)
- Never fill anything but fresh, cold clean water into the water container, except when decalcifying (chapter 20b).
- Never use mineral or carbonated water. You can use tap water, spring water, distilled water and reverse osmosis water.
- Never repair or open the machine yourself. All repairs should be performed only by an authorized service center.

PLEASE, DO...

- Fill water tank with fresh, cold water only.
- Remove any foreign particles (small stones) from coffee beans.
- Let frozen beans thaw for 3 to 4 hours before pouring them into the bean container.

All Display Messages Are Shown in **RED**

5. FACTORY SETTINGS

Each machine leaves the factory with the following settings:

Filter NO

Hardness Level 2

Aroma ROBUST

Auto Off 2 hours after last use

Language English

Cup Size OZ.

Rinse ✓

The Dial is set to **4 OZ.** for coffee and for hot water and for **60 SEC** for steam.

6. PREPARING THE MACHINE FOR THE FIRST TIME

- Make sure all accessories, literature and any other items are removed from the machine and the water tank.
 - Make sure the machine sits on an even, flat surface and the drawer, tray and used coffee container are inserted (Fig 2).
 - Plug-in machine.
 - Do NOT fill water tank now.
- Important:** Do not install the Clearyl Water Filter cartridge now. It can block the machine.
- Turn the machine on by pressing the ON/OFF button (Fig. 3a). The display shows **FILL WATER.**
 - Remove water tank, fill with fresh, cold water and replace.

The display shows **OPEN TAP**

The following procedure is only necessary when setting up the machine for the first time and after the procedure "Emptying System Before Transport" (chapter 19f).

- Place a cup underneath the frother (Fig. 13) and turn the Steam/Water Selector to the Steam /Water symbol Fig 4b). **SYSTEM FILLING.** The machine will pump some water through the frother and stop automatically. **SHUT TAP.** Turn the Steam/Water Selector back to the cup symbol. **HEATING. PRESS RINSE.** Place a cup underneath the Coffee Spout (Fig. 1,1) and press the Rinse Button (Fig. 3f). The machine will pump a bit of hot water through the coffee spouts and will stop automatically. **READY.** You can only brew coffee when the display shows **READY.**
- Open the bean container lid (Fig. 1, 9) and fill with beans (Fig. 5) for details see chapter 7.
- Place an empty cup (at least 8 oz.) under the coffee spouts.
- Push the Dial (Fig. 3e). The Dial illuminates and the display shows the cup size **4 OZ.**
- Push and hold the 1-Cup button until the display reads **STRONG.** The Impressa E starts grinding and will start brewing. Initially, the grinding chamber may not fill properly with ground coffee. The machine will start brewing, then interrupt and the display will show **FILL BEANS.** Push the 1-Cup button again. Discard this first cup of coffee. Your next cup will be perfect. **Please note:** If coffee only comes out of one spout, move the spout up and down a few times to clear the internal flow. You are now ready to make coffee.

7. ADDING COFFEE BEANS

- Open the bean container lid (Fig. 1, 9), fill with beans (Fig. 5). The container holds approx. 220 grams (8 oz.). Close the lid. **Frozen Beans:** Thaw for 3 to 4 hours before adding to bean container. This prevents moisture from seeping into the grinder.

Sugar Coated Beans: DO NOT fill sugar coated beans into the bean container. The sugars will stick to the burrs and clog the flow of ground coffee. Have your local coffee store grind the sugar coated beans and use as described in chapter 11.

Using Oily Beans: Beans with an oily surface tend to stick together. This may prevent a continuous flow of beans from the bean container into the burrs. As a result the grinder does not grind enough coffee and you might get weak or no coffee at all. Stir the beans in the bean container just before grinding. Alternatively, you can also pour the beans in an open bowl and let them sit for about 5 hours. The oils will evaporate (this will not change the taste of your coffee). Then fill the beans into the bean grinder. Now beans will feed into the burrs more easily.

8. ADJUSTING THE GRINDER

You can adjust the grinder to the roast of your coffee.

We recommend the following:

Light roast: use a finer adjustment.

Dark roast: use a coarser adjustment.

- Open the lid of the bean container.
- While the grinder is running turn the grind selector switch to the desired position (Fig. 6).
 - The smaller the dots, the finer the grind.
 - The bigger the dots, the coarser the grind.

Important: The grinding grade can only be adjusted while the grinder is actually grinding.

9. DAILY PREPARATION

ON/OFF Button – **HEATING** – **RINSE** – **READY**

We recommend filling the water container every morning with fresh, cold water. This will enhance the taste of your coffee.

- Push and hold On/Off button until the display turns on. If your machine is cold the display shows **HEATING**. After approx. 2 minutes the display shows **RINSE**.
- Press the Rinse Button (Fig. 3,f). Hot water will warm up all internal parts and pump through the coffee spouts. The water will be caught in the drawer underneath. The rinse cycle stops by itself and the display reads: **READY** You are now ready to make coffee.

10. GRINDING AND BREWING

The Impressa E uses a 2-step brewing process (Pre-Brew Aroma System). First it moistens the ground coffee (pre-brew phase), pauses for a few seconds and then starts the brewing process.

- Adjust the height of the coffee spout to your cup size (Fig. 12) and place one or two cups underneath the coffee spouts.

10a. SELECTING CUP SIZE AND STRENGTH

Cup Size 1 OZ. to 8 OZ.; max: 16 oz.

- Push the Dial. It will illuminate and the display will show the cup size in oz, e.g. **4 OZ.**
- Turn the dial to select any cup size between **1 OZ.** and **8 OZ.** Your machine will always remember the last setting. After 5 seconds the display will change back to **READY**.
- When using the **2-Cup** button the machine will automatically double the selected amount of coffee.

Coffee Strength MILD – NORMAL – STRONG

Push the 1-Cup button once, the display shows **MILD**.

Push the 1-Cup button twice, the display shows **NORMAL**.

Push the 1-Cup button three times, the displays shows **STRONG**.

You can also push and hold the 1-Cup button until the desired strength is shown in the display.

Grinding times (approx.)

MILD 6 to 7 seconds.

NORMAL ... 7.5 to 8.5 seconds.

STRONG..... 9 to 10 seconds.

AROMA-setting "**STANDARD**" has the shorter grinding times.

AROMA-setting "**ROBUST**" has the longer grinding times.

When using the 2-Cup button the grinder will always grind between 9 and 10 seconds.

Please note:

When using the 1-Cup button, the display will first show the strength setting. When the pre-brew cycle starts, it will show the actual cup size. At this time you can still change the cup size by turning the Dial.

When using the 2-Cup button, the display will first show **2 CUPS**. When the pre-brew cycle starts, the display shows the cup size for one cup. At this time you can still change the cup-size by turning the Dial.

Please note: After the pre-brew cycle you can always stop the brewing process by pushing the 1-Cup or 2-Cup button. This will not affect your cup size setting for the next brew cycle.

Important: Never try to pull out the tray as long as the machine is grinding, brewing or discarding the used coffee. Always wait until the display shows **READY**.

11. USING PRE-GROUND COFFEE

You can also use pre-ground coffee, bypassing the grinder. This comes in handy if someone requests decaf, sugar coated or flavored coffee.

- Push the Pre-Ground Coffee Button (Fig. 3h). The display shows: **FILL POWDER**

- Open the lid for the ground coffee funnel (Fig. 1.8) and fill the funnel with one or two scoops of ground coffee.

Important: Do NOT fill this funnel with instant coffee and do not use more than two level scoops of coffee.

- Push the 1-Cup or 2-Cup button. The machine will tamp and brew coffee.

Please note: If you push the scoop button accidentally push the 1-Cup button. Display shows **ADD MORE POWDER**. The machine will start brewing, stop and return to **READY**.

Please note: After use of sugar coated or flavored coffee through the pre-ground coffee funnel you may experience some flavor transfer when going back to your regular coffee.

- Push and hold the Rinse Button (Fig. 3f) until the display shows **RINSE**.
- The Dial illuminates. Push the Dial (Fig. 3e). The machine will perform one rinse cycle and the display will return to **READY**.

12. USING HOT WATER

READY – 1 OZ. to 16 OZ. – SHUT TAP - READY

The hot water feature allows you to make a cup of tea, a quick soup or add hot water to your coffee, making it less strong.

- Place a cup underneath the frother (Fig. 13).
 - Turn the Steam/Water Selector to the water symbol (Fig. 4b). Hot water will push through the frother. The display shows the amount of hot water. You can change it from 1 to 16 oz. by turning the Dial (Fig. 3e) now. The machine remembers the last setting. When the water flow stops, display shows **SHUT TAP**.
 - Turn the Steam/Water Selector back to the cup symbol. **READY**.
- Please note:** You can always stop the flow of hot water by turning the dial to the cup symbol.

13. FROTHING and STEAMING

The steam function can be used to heat up any liquid and to steam and froth milk.

Steaming Position:

The Frother's metal cylinder is in the UP position (Fig. 16). In the steaming position hot steam is injected into the milk (or any other liquid) without creating a frothy layer on top.

Typically a Latte has steamed milk with no froth.

Frothing Position:

The Frother's metal cylinder is in the DOWN position (Fig. 16). In the frothing position hot steam and air is injected into the milk creating warm milk and a firm layer of tiny froth bubbles.

14. HEATING AND FROTHING MILK

READY – HEATING - STEAM READY - 60 SEC - CLOSE TAP

- Push the Steam button (Fig. 3g). Display shows **HEATING**.
- Add cold milk to a pitcher or a cup.
- After 15 to 30 seconds the display shows **STEAM READY**.
- Immerse the tip of the frother into the milk (Fig 17&18) and turn the Steam/Water Selector to the Water/Steam Symbol. Hot steam will be injected into the milk. The display shows how long steam will be forced through the frother, **60 SEC**.
- At this time you can change the steam output from 3 and 120 seconds. The machine will remember your last setting. When the selected steam time is up, the display shows **SHUT TAP**.
- Turn the Steam/Water Selector to the cup symbol. If you need more steam turn the Selector back to the water/steam symbol.

Please note: You can always stop the steam output by turning the Steam/Water Selector to the cup symbol.

Please note: When you start steaming, some hot water will push out of the nozzle before the steam begins. When frothing a lot of milk this will not change the taste of your frothed milk. You can also release this small amount of hot water into the tray or into a separate container:

- Turn the Steam/Water Selector to the Water Symbol for one second and then back to the Cup symbol. Now start frothing/steaming.

Please note: When you stop the steam output the display will show **STEAM READY** for the next 20 seconds. Within this time you can continue to use the steam function.

If you want to steam at a later time you must first press the Steam button (Fig. 3g).

Tips for frothing (Cappuccino):

The tip of the frother should not touch the bottom of your pitcher. Start in the steaming position – cylinder "up" (Fig. 16) – for a few seconds. Then push the cylinder "down". Milk froth will build up. This way the froth on top of your milk is also warm. If the frothed milk is not warm enough, continue in the steaming position.

Steaming and frothing directly in your cappuccino cup:

With practice, you can steam and froth directly in your cappuccino cup. First steam and froth the milk, then add your espresso shot.

Please note: The less fat content the milk has the more froth will be created. Skim milk will produce the most froth and will let you taste more of the coffee. 1% and 2% milk will give you less froth. Regular whole milk (3% fat) will produce the least amount of froth. You can also use soy milk.

15. CLEANING THE DUAL FROTHER PLUS

Always keep the Dual Frother Plus clean and free of milk deposits. Hardened milk particles will make it impossible to create milk froth.

Fast cleaning:

Display shows **READY**. Place a cup underneath the frother (Fig. 13) and turn the Steam/Water Selector to the water symbol. Let hot water run through the frother for about 3 seconds and then stop. This will flush out any small milk droplets.

Thorough cleaning of the Dual Frother parts:

- Remove the Dual Frother (Fig. 14) from the Steam Nozzle (Fig. 15c) by pulling down the soft collar of the clip-on connector.
- Unscrew the black tip (Fig. 14a) from the Clip-On Connector (Fig. 14c). You can use a coin to loosen the black tip.
- Soak all three parts in hot soapy water.
- Make sure that the two side holes and the channel of the black tip (Fig. 14a) are free of any milk deposits.

Cleaning the Steam Nozzle (Fig. 15c)

- Place a cup underneath the Steam Nozzle (the Dual Frother is off) and let a bit of hot water run through the Steam Nozzle.
Tip: If the steam nozzle is blocked by hardened milk, use a needle and loosen up the milk deposit. Then let some hot water pass through the Steam Nozzle.

Assembly of Frother Parts

- Make sure the Steam Nozzle is screwed onto the Metal Tube (Fig. 15a) finger tight.
- Assemble the Dual Frother and make sure that the tip is screwed onto the Connector finger tight (Fig 14a, c).
- Push the black Clip-on Connector (Fig. 14c) firmly into the

steam nozzle (the connector should sit flush with the chrome sleeve (Fig. 15b) so that the steam nozzle is no longer visible).
Please note: If the parts are not put together tightly it will not be possible to create the frothy foam on top of the milk.

16. CLEARLYL WATER FILTER CARTRIDGE

The machine comes with one Water Filter Cartridge. This cartridge is specially made for use with the Impressa E series.

The cartridge:

- Reduces the water hardness up to 75%.
- Removes (if present) up to 85% chlorine, up to 90% lead, up to 95% copper and up to 67% aluminum.
- Cleans the water through an upward current principle (Fig. 8) just before the brewing cycle starts, ensuring freshly filtered water every time you make coffee.
- Eliminates decalcifying. When using the water filter cartridge, you never need to decalcify your machine.
- To reorder cartridges see chapter 22 "Supplies".

16a. INSTALLING & ACTIVATING THE CLEARLYL WATER CARTRIDGE

Important: Never install the cartridge before or during "Preparing Machine For The First Time."

- Make sure the water tank is empty.
- Remove cartridge from its bag and rinse cartridge under water
- Open water container lid and pull up the holder for the cartridge (Fig.9).
- Insert the cartridge with its tapered end down. Make sure it fits snugly over the white mesh piece inside the water container. Push down gently (Fig.10).

- Close the holder for the cartridge so that it engages in the water tank (Fig.11).
- Fill the water tank with fresh cold water and replace.

You must activate the cartridge as follows:

1. Push and hold the P button (Fig. 3e). **FILTER –**
2. Push the Dial and the display shows **NO –**
3. Turn the Dial until the display shows **YES ✓**
4. Push Dial confirm. The display shows **INSERT / OPEN TAP**
5. Place a 20 oz. container underneath the frother.
6. Turn the Steam/Water Selector to the water symbol.

FILTER RINSING. For the next 90 seconds the machine will push water through the filter and through the frother. Do not interrupt this process. This activates the filter. The machine will stop automatically.

7. **SHUT TAP.** Turn the Water/Steam Dial back to the cup symbol. **HEATING. READY.**

Please note: As long as the filter is activated, the water hardness setting is automatically turned off.

16b. REPLACING THE CLEARLY WATER CARTRIDGE

The filter is monitored automatically. After approx. 75 liters of water (~2,500 oz.), the filter loses its effect. The display changes from **READY** to **CHANGE FILTER / MACHINE READY**. You can still make coffee, but we recommend replacing the filter within one week!

Attention: The filter should be changed every 3 months if you use less than 75 liters of water. In this case, no message will appear in the display.

Important: Once the filter has lost its calcium suppressing abilities, calcium will build up inside the machine. Since the

Water Hardness Selector is off, the machine will not remind you when to decalcify. This could clog and ruin your machine.

- Remove the old filter. The cartridge is environmentally friendly. Dispose it with your regular household trash.
 - Make sure the water tank is empty.
 - Remove the new cartridge from its bag.
 - Open water container lid and pull up the holder for the cartridge (Fig. 9).
 - Insert the cartridge with its tapered end down into the water container. Make sure it fits securely inside the fins. Push down gently (Fig.10).
 - Close the holder for the cartridge so that it engages in the water tank (Fig.11).
 - Fill the water tank with fresh cold water and replace.
1. Push and hold the Rinse Button. The display shows **RINSE** and the Dial is illuminated.
 2. Turn the Dial until the display shows **FILTER.**
 3. Push the Dial. The display shows **REPLACE OPEN TAP.**
 4. Place a 20 oz. container underneath the frother.
 5. Turn the Steam/Water Selector to the water symbol.

FILTER RINSING

For the next 90 seconds the machine will push water through the filter and through the frother. Do not interrupt this process. This activates the filter. The machine will stop automatically.

6. **SHUT TAP.** Turn the Water/Steam Dial back to the cup symbol. **HEATING. READY.**

17. ADJUSTING THE WATER HARDNESS

Water is heated inside the machine. With use, this leads to calcium deposits forming inside the machine. The display will

remind you when it is time to perform a decalcifying cycle. The machine is set to level 2 (medium hard water). If you have harder water you need to set it to a higher level. If you have softer water you can set it to level 1. If you are not sure about the hardness of your water, ask your local water company for the "Water Hardness in Grains."

HARDNESS LEVEL 1: grains 2-9

HARDNESS LEVEL 2: grains 10-19

HARDNESS LEVEL 3: grains 20-29

HARDNESS LEVEL 4: grains 30+

You can also use the enclosed water hardness indicator strip to determine the water hardness:

- Insert the stick for one second into the water you want to use. Shake off any excess water and wait for one minute.
- If all five fields of the test stick turn reddish, set the hardness level to 4. If four fields turn reddish, set the hardness level to 3. If three or less fields turn reddish, leave the level in position 2.
- If you use Spring Water you can set the hardness level to 1.

You can change the hardness settings as follows:

1. Push and hold the P button (Fig. 3e). **FILTER -**
2. Turn the Rotary Dial until the display shows **HARDNESS**.
3. Push the Dial. **LEVEL 2**
4. Turn the Dial to select from **1 2 3 4 -**
5. Push the Dial to confirm your selection. **HARDNESS**.
6. Push the P button. **READY**.

Important: If you choose the selection "-" the water hardness monitor is turned off. In this case the machine will NOT remind you when it is time to decalcify. Turning off the monitor requires you to use distilled water only or the Water Filter Cartridge (chapter 16a).

18. PROGRAMMING

Please note: As long as you are in programming mode, you cannot brew coffee.

- Press and hold the P button until the display shows **FILTER**. Turning the Dial clockwise the following functions will appear in the display:

HARDNESS

AROMA

AUTO OFF

STATS

LANGUAGE

ML / OZ

RINSE ✓

To change functions the procedure is always the same:

1. Push and hold P button until display shows **FILTER**.
2. Turn Dial to the function you want to change or look up.
3. Push Dial.
4. Turn Dial until desired selection is displayed.
5. Push Dial to confirm selection.
6. Push the P button to get back to **READY**.

FILTER: See chapter 16a.

HARDNESS: See chapter 17.

18a. AROMA

1. Push and hold P button until display shows **FILTER**.
2. Turn Dial to **AROMA**
3. Push Dial: **ROBUST**
4. Turn Dial to select from **STANDARD** or **ROBUST**
5. Push Dial to confirm selection.

6. Push the P button to get back to **READY**.
In **ROBUST** the grinder will always grind approx. 1 second longer to increase the strength of your coffee.

18b. AUTO SHUT-OFF

1. Push and hold P button until display shows **FILTER**.
 2. Turn Dial to **AUTO OFF**
 3. Push Dial: **2.0 HRS**
 4. Turn Dial to select from **-. HRS** to **9.0 HRS**
 5. Push Dial to confirm selection.
 6. Push the P button to get back to **READY**.
- In selection **-. HRS** the machine will not shut off automatically.

Please note: When the machine turns off, it will automatically run a hot water rinse cycle. The water will push through the coffee spouts and will be caught in the tray.

Recommendation:

- If you use the machine in the morning and then later in the day, set the auto-shut off between 0.5 HRS and 2.0 HRS.
- If you use the machine all day long set the auto shut off between 3.0 HRS to 5.0 HRS.
- If you make only one or two cups of coffee in the morning, set the machine to 0.5 HRS.

Important: Never turn the machine off immediately after you have made a cup of coffee. The automatic hot water rinse cycle works more effectively after the brewing chamber has cooled down.

18c. STATS (usage)

1. Push and hold P button until display shows **FILTER**.
2. Turn Dial to **STATS**
3. Push Dial: The display shows the total number of cups brewed.

4. Push the 1-Cup, 2-Cup and the Ground Coffee Button to display usage for those buttons.
5. Push the P button TWICE to get back to **READY**.

18d. LANGUAGE SELECTION

1. Push and hold P button until display shows **FILTER**.
2. Turn Dial to **LANGUAGE**
3. Push Dial: **ENGLISH**
4. Turn Dial to select from English, German, French, Italian Spanish, Portuguese, Dutch (NL)
5. Push Dial to confirm selection.
6. Push the P button to get back to the **"READY"** mode.

18e. ML/OZ

Instead of showing the cup sizes in Ounces (OZ) you can display it in Milliliters (ML). 30 ML equals 1 OZ.

1. Push and hold P button until display shows **FILTER**.
2. Turn Dial to **ML / OZ**
3. Push Dial: **OZ**.
4. Turn Dial to select **ML** or **OZ**.
5. Push Dial to confirm selection.
6. Push the P button to get back to **READY**.

18f. RINSE

You can turn off the automatic rinsing mode for when the machine shuts down.

1. Push and hold P button until display shows **FILTER**.
2. Turn Dial to **RINSE**
3. Push Dial: **RINSE ✓**
4. Turn Dial to select **RINSE –**

5. Push Dial to confirm selection.
6. Push the P button to get back to **READY**.

19. CARE AND MAINTENANCE

19a. FILL WATER

When the display shows **FILL WATER**, no more coffee can be made until you fill the water container. The water container will never be completely empty. The low water floatation device (Fig. 7.4) activates the **FILL WATER** indicator when there are about 10 oz. of water left.

- Remove water tank, rinse and fill with fresh water and replace.

19b. EMPTY GROUNDS

Used coffee grounds are collected in the used coffee container (Fig. 2.19). If the display shows **EMPTY GROUNDS**, no more coffee can be made until you empty the used coffee container.

- Carefully lift and remove drawer since there is water in it (Fig. 19).

The display shows **DRAWER MISSING**.

Important: Do not unplug the machine while you are emptying the coffee grounds.

- Empty the used coffee container and the drawer.
- Push the drawer back into the machine (Fig. 20). The display still shows **DRAWER MISSING**.
- Place the used coffee container on the tray and insert back into the machine (Fig. 21). The display shows **READY** and you may now continue brewing coffee.

19c. FILL BEANS

When the display shows **FILL BEANS**, open the bean container lid and add beans (Fig. 5).

Please note: The message **FILL BEANS** will disappear after making the next cup of coffee.

Attention: If the display shows **FILL BEANS** and there are ample beans in the bean container, stir the beans so they flow into the grinder (chapter 7). We recommend cleaning the bean container from time to time with a dry cloth before you refill beans (please make sure the machine is turned off when cleaning).

19d. STONES AND BEANS

Every coffee specialty store will tell you that occasionally small stones can be found in with coffee beans. Small stones will be processed through the burr grinder without any harm (the stone will end up in the used coffee container).

However larger stones can block the burr grinder. The noise of the grinder will become very loud and the grinder will block. In this case please call our Customer Service: 1-800-220-5701.

Before Filling Beans into the Bean Container:

- Shake your bean bag thoroughly so that a stone will fall to the bottom of the bag.
- Before emptying the bean bag completely, check if there are any particles that look like stones and remove them.

19e. GENERAL CLEANING INSTRUCTIONS

Never use abrasive materials or chemicals to clean the machine.

- Clean the housing with a soft, damp cloth.
- Rinse water tank daily and fill with fresh, cold water.

19f. EMPTYING SYSTEM BEFORE TRANSPORT

This procedure is necessary to prevent water and frost damage in case you intend to transport your machine.

- Turn machine off.

- Place a cup underneath the frother.
- Push and hold the Steam Button until the display shows: **OPEN TAP**. Turn the Steam/Water Selector to the water symbol. The machine will push a bit of water and steam into the cup underneath the frother.
- When display shows **CLOSE TAP** turn the Steam/Water Selector back to the cup symbol. The machine will automatically shut off. **Important:** The next time you turn the machine on you must follow the instructions in chapter 6.
Please note: Before transporting the machine, make sure that the water tank is empty, the filter cartridge is removed (discard and use a new cartridge), the bean container is empty, the drawer and used coffee container are empty and clean. Secure the lids of the water tank and the bean container with scotch tape. Pack entire machine with thick cushioning material on all sides to prevent damage.

20. AUTOMATIC CLEANING CYCLES

20a. RINSING

You can run an extra hot water rinse cycle as follows.

- **READY**. Push and hold the Rinse button until display shows **RINSE**. The Dial illuminates.
- Push the Dial. Hot water is dispersed through the coffee spouts and will stop automatically. **READY**.

20b. CLEANING WITH SPECIAL TABLET

The machine monitors how many coffees are brewed and how often the rinsing program is activated. After approx. 200 coffees the display will show **CLEAN MACHINE / MACHINE READY**.

Please note: You can continue making coffee, however we

highly recommend that you clean the machine as described below within the next few days. This cleaning program will remove oil build-ups in the brewing chamber. The cleaning program takes about 15 minutes. Please use one white cleaning tablet (enclosed). The machine comes with a pack of 2 tablets. To re-order cleaning tablets see chapter 22.

Important: Once the cleaning program has started do not interrupt the procedure.

1. Make sure the machine is on and the water tank is full.
2. Push the Rinse button. The display shows **EMPTY DRAWER**.
3. Remove and empty the drawer and used coffee container and replace complete assembly (Fig. 21).
Important: Even if the drawer and the used coffee container are empty, you still need to remove the drawer for approx. 20 seconds and then replace it. The display shows **PRESS RINSE**.
4. Place a 12 oz. container under the coffee spouts.
5. Push the Rinse button. The display shows **CLEANING**.
After a moment the display shows **ADD TABLET/ PRESS RINSE**.
6. Open the ground coffee lid and drop in one white cleaning tablet (Fig. 22). Your machine comes with a pack of two tablets. To order more tablets see chapter 22 "Supplies".

7. Push the Rinse button. The display shows **CLEANING**.
The cleaning program will dispense hot foamy water in intervals through the coffee spout into the drawer.
8. When finished, the display shows **EMPTY DRAWER**.
9. Lift and remove the drawer. Empty the used coffee container and drawer and replace. The display shows **READY** indicating the machine is now ready to brew coffee again.
Attention: You can run a tablet cleaning cycle at anytime even if

the machine does not prompt you,

- **READY**. Push and hold the Rinse button until display shows **RINSE**. The Dial illuminates.
- Turn the Dial until display shows **CLEANING**. Push the Dial. Display shows **EMPTY DRAWER**.
- Continue with step 3 above.

20c. DECALCIFYING PROCEDURE

The machine has an integrated decalcifying program. When the display shows **DESCALE MACHINE / MACHINE READY** it is time to decalcify the machine. You can still make coffee. However, it is highly recommended that you decalcify the machine within the next 3 to 4 days.

Please note: If you use the Clearyl water cartridge and the display shows **DESCALE MACHINE / MACHINE READY**, then your cartridge function is not activated. Follow the instructions in chapter 16a to program the Clearyl Cartridge function.

Important: The decalcifying program must not be interrupted.

DECALCIFYING AGENT: Only use our special decalcifying tablets. For supplies see chapter 22.

CAUTION: Never use vinegar or any other decalcifying agent. This might damage internal parts of the machine.

1. Push the Rinse button. The display shows **EMPTY DRAWER**.
2. Remove and empty the drawer and used coffee container and replace complete assembly (Fig. 21).

Important: Even if the drawer and the used coffee container are empty, you still need to remove the tray for approx. 20 seconds and then replace it. The display shows **SOLVENT IN TANK**.

3. Make sure the water tank is empty. Completely dissolve three of the large square tablets in 16 oz. of water and pour this mixture into the water tank.
4. Replace water tank. Place a large container (at least 20 oz.) underneath the frother.
5. The displays shows **SOLVENT IN TANK OPEN TAP**. Turn the Steam/Water Selector to the water symbol. The machine will pump the mixture through the frother in intervals. During this procedure the display shows **DECAL ON**. When this cycle is finished the display shows **SHUT TAP**.
6. Turn the Steam/Water Selector back to the cup symbol. The display shows **DECAL ON**. Now the machine pumps the mixture through the coffee spout into the drawer.
7. When this cycle is completed the display shows **EMPTY DRAWER**. Remove the container from underneath the frother. Carefully lift and remove the drawer, empty and thoroughly rinse all parts and replace. The display shows **FILL WATER**.
8. Remove the water tank, rinse thoroughly, fill with cold fresh water and replace.
9. Place a large container (at least 20 oz.) underneath the frother. The display shows **OPEN TAP**.
10. Turn the Steam/Water Selector to the water symbol. The machine will pump hot water through the frother in intervals. During this procedure the display shows **DECAL ON**. When this cycle is finished the display shows **SHUT TAP**.
11. Turn the Steam/Water Selector back to the cup symbol. The display shows **DECAL ON**. Now the machine pumps hot water through the coffee spout into the drawer.
12. When the cleaning cycle is completed the display shows

EMPTY DRAWER. Remove the container from underneath the frother. Carefully lift and remove the drawer, empty and thoroughly rinse all parts and replace. The display shows **PRESS RINSE.**

13. Push the Rinse Button. The machine will run a regular rinse cycle and the display will show **READY.**

14. Clean front of machine and grid with a moist, soft cloth.

Attention: You can run a decalcifying cycle at anytime even if the machine does not prompt you,

- **READY.** Push and hold the Rinse button until display shows **RINSE.** The Dial illuminates.
- Turn the Dial until display shows **DECAL ON.** Push the Dial. Display shows **EMPTY DRAWER.**
- Continue with step 2 above.

21. TIPS FOR BETTER COFFEE

Height adjustable coffee-spout

Adjust the height of the coffee-spout to the size of your cups.

Grinding

Please refer to chapter 8 "Adjusting the Grinder."

Pre-warm cups

You should warm cups in advance with hot water or steam.

The smaller the quantity of coffee, the more important it is to warm your cups.

Sugar and cream

Warmth is lost by stirring the contents of the cup. Adding milk or cream from the refrigerator considerably lowers the temperature of the coffee. You can preheat milk and cream with the frother.

22. SUPPLIES AND ACCESSORIES

The following supplies are necessary to keep your machine in good working order:

- Clearyl Water Filter Cartridge - Model #64533
 - Special Cleaning Tablets (white tablets) - Model #62205
 - Decalcifying tablets (large square tablets) - Model #61848
- Please note:** You must use decalcifying tablets if you do not use the Clearyl cartridge.
- frothXpress Plus System - Model #64342

All supplies are available through:

- the enclosed mail order form that came with your machine
- our toll free line at 1-800-220-5701 or
- the Internet at www.cappresso.com.

23. FROTHXPRESS PLUS SYSTEM WITH MILK CONTAINER

If you prepare many Cappuccinos or Lattes at a time, we recommend the fast and precise frothXpress Plus System. The system replace the Dual Frother Plus and allows you to fill cup after cup with the desired amount of hot milk and milk froth automatically. See video for details. Sold separately.

24. TROUBLESHOOTING

A. NO COFFEE COMES OUT OF THE COFFEE SPOUT

Reason: Beans in bean container are not feeding properly into the grinder because they are stuck together.

Solution: Stir beans before grinding and while grinding turn the grinding selector to the coarsest setting. See chapter 7.

Reason : You used ground coffee in the ground coffee funnel. The ground coffee was too fine.

Solution: Use ground coffee which is ground somewhat coarser.

Reason : No water is transported through the system.

Solution: Remove water container and make sure that the connecting valve is free of any particles (like a coffee bean etc).

Reason: The ground coffee funnel or the internal brewing chamber is clogged.

Solution: Place a large cup underneath the coffee spout. Push the Rinse button (Fig. 3f) until the display shows **RINSE**. Push the Dial (Fig. 3e) **RINSING. READY**. Repeat the process if necessary until the blocked coffee is pushed into the used coffee container.

B. THE DISPLAY READS "FILL WATER" BUT THERE IS ENOUGH WATER IN THE WATER TANK.

Reason: The low water floatation device (Fig. 7.4) is missing.

Solution: Within the water tank is a small compartment (like a mouse trap). Inside is a small black floatation device. On top is a small clear see-through plastic cover. This small plastic cover is missing and the floatation device is outside of the small compartment. Check if you can locate both pieces and put it back together. If you cannot find them, call 1-800-220-5701. We will send the pieces to you **FREE OF CHARGE**.

C. INSUFFICIENT FROTHED MILK PRODUCTION

Reason: Milk is initially not cold enough or your milk is not suited for thick frothing.

Solution: Make sure milk is cold. Use a different type of milk. Skim milk will produce the thickest and longest lasting froth. Full fat milk will produce less thick froth. See chapter 14.

Reason: The components of the frother are not assembled properly, or the components are clogged with hardened milk, or one or more of the components is missing, or the steam nozzle

is clogged.

Solution: (See chapter 15)

- Remove frother. Check that steam comes out of the steam nozzle. If not, use a needle and clear blockage from inside steam nozzle.
- Clean all other frother parts and assemble properly.
- If any parts are missing call Customer Service: 1-800-220-5701 or use the enclosed mail order form to order the missing part.

D. GRINDER MAKES AN EXTREMELY LOUD NOISE; NO BEANS ARE GROUND

Reason: A stone is blocking the burr grinder.

Solution: Call customer service: 1-800-220-5701.

E. THE DRAWER (Fig. 19) DOESN'T PULL OUT OR DISPLAY SHOWS **MALFUNCTION 8**

Solution: Turn off and unplug machine. Wait a minute. Turn machine on and wait until it stops making any noise. Now try to pull out the drawer. If this does not work, try the above procedure again. If this does not work, call customer service:

25. LIMITED WARRANTY

Please note: This warranty will be void if the Warranty / Product Registration has not been received two weeks after the purchase date (you can fax or mail the registration or you can register through our website www.cappresso.com)

This limited warranty covers your new IMPRESSA E Series for household use only (commercial use voids warranty): **One Year or 4,000 coffee brewings, whichever comes first.**

This warranty is in effect for the period and usage described above from the date of the first purchase and is limited to the United States of America. This warranty covers all defects in materials or workmanship (parts and labor) including free UPS ground transportation for both ways within the continental United States. For Hawaii and Alaska freight is not covered by this warranty.

TRANSPORT: When sending the machine, use the original packing materials, the inner and outer cartons or use approximately 2" of bubblewrap and insert machine in a carton which will hold 40lbs. Any damage in transit is NOT covered by this warranty.

This warranty does not cover:

- Any machine NOT distributed by JURA-CAPRESSO within the United States.
- Any machine not purchased from an Authorized Dealer.
- Damage caused by accident, abuse, negligence, misuse, improper operation or failure to follow instructions contained in this manual.
- Any service or alteration performed by an unauthorized person, company or association.
- Damage caused by neglecting and omitting maintenance, cleaning and decalcifying cycles.
- Damage caused by use of instant coffee or any other ingredients not allowed in this product.

Other limitations and exclusions:

Any implied warranties including fitness for use and merchantability are limited in duration to the period of the express warranty set forth above and no person is authorized to assume for JURA-CAPRESSO any other liability in connection with the sale of the machine. JURA-CAPRESSO expressly disclaims liability for

incidental and consequential damages caused by the machine. The terms "incidental damages" refer to the loss of the original purchasers time, loss of the use of the machine or other costs relating to the care and custody of the machine. The terms "consequential damages" refer to the cost of repairing or replacing other property which is damaged when this machine does not work properly. Any loss of income is excluded. The remedies provided under this warranty are exclusive and in lieu of all others. This warranty gives you specific legal rights, and you may also have other rights which vary from state to state.

**CUSTOMER SERVICE:
1-800-220-5701**

Mon-Fri 9AM – 9PM

Sat 9AM – 5PM (EST)

email: contact@capresso.com

Jura-Capresso LLC.

81 Ruckman Road
Closter, NJ 07624

Telephone: 201-767-3999

Fax: 201-767-9684

Website: www.capresso.com